

**Company ID:** 174 TV-Italy

**Main Process:** Mechanical precision machining

**Other Process:** Milling in general  
Turning in general  
Grinding in general  
Mechanical machining in general  
Turning for small and medium series, > 60 mm  
Milling from solid material in small/medium series, table L = 1300-1600 mm

**Materials:** Stainless steel, Aluminium, Brass, Plastic, Copper, Titanium

**Markets:** ITALY, WESTERN EUROPE

**Customers:** Equipment for chemical, petrochemical and oil industry  
Automatic equipment for dosage and packaging  
Industry and components  
Mechanical machinery and equipment  
Energy sector in general  
Aerospace and aeronautics in general

**Turnover:** 1-5 Mln €

**Certifications:** ISO 9001:2008

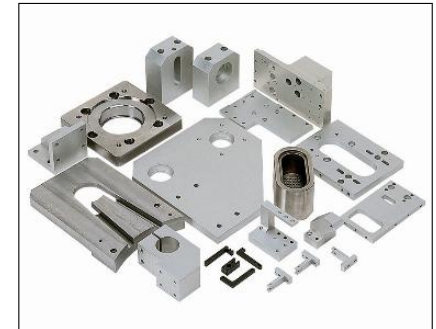

**Company ID:** 3195 FI-Italy

**Main Process:** **Mechanical precision machining**

**Other Process:** Turning for small and medium series, > 60 mm  
Mechanical machining for medium large dimension  
Milling in general  
Heat treatments in general  
Wear protection

**Materials:** Stainless steel, Bronze alloys, Special steel, Hardened steel, Inconel, Superalloys

**Markets:** ITALY, WESTERN EUROPE

**Customers:** Petrochemistry  
Oil and gas  
Renewable energy  
Equipment for chemical, petrochemical and oil industry  
Pumps and compressors

**Turnover:** 1-5 Mln €

**Certifications:** ISO 9001:2000      ISO 14001

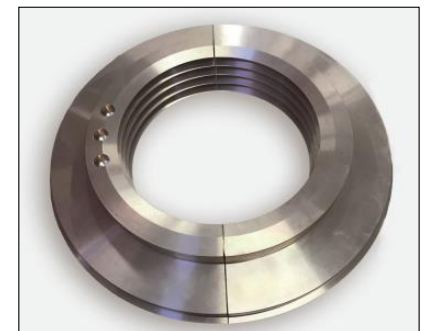

**Company ID:** 836 Vicenza-Italy

**Main Process:** Mechanical machining in general

**Other Process:**  
Turning in general  
Milling in general  
Metal constructions in general  
Welding in general  
Stress relieving at low temperatures  
Assembling groups in general

**Materials:** Steel, Stainless steel, Aluminium , Bronze, Cast iron, Tube

**Markets:** ITALY, FAR EAST

**Customers:**  
Energy sector in general  
Lifting and mechanical handling appliances and machinery  
Machinery for food, beverage and tobacco processing  
Industry and components  
Oil hydraulics components  
Other

**Turnover:** 5-10 Mln €

**Certifications:** ISO 9001:2008

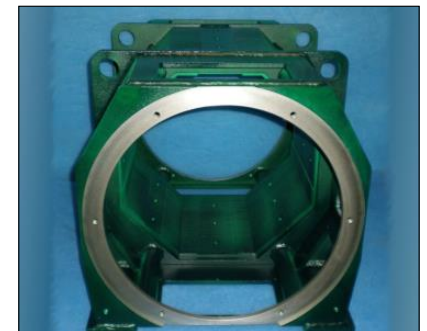
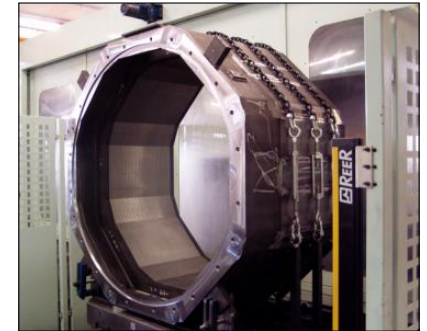

**Company ID:** 3150 TV-Italy

**Main Process:** 2D Laser cutting for small/medium series

**Other Process:**  
Metalsheet bending by press brake in general  
2D Laser cutting for medium/large series  
Sheet bending by oil hydraulic press brake, small/medium series, L= 3000-4000 mm  
Punching in general  
Metal sheet calendaring in general  
Welding in general

**Materials:**  
Stainless steel, Aluminium, Pickled steel, Metal sheet, Rolled steel, Stainless rolled steel

**Markets:**  
ITALY

**Customers:**  
Pasta and farinaceous products  
Components and plant parts for the food and wine-making industries  
Machine tools  
Machinery for food, beverage and tobacco processing  
Automatic equipment for dosage and packaging  
Machines for the pharmaceutical sector

**Turnover:**  
1-5 Mln €

**Certifications:**  
No certification

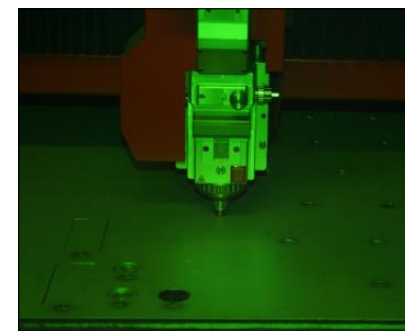
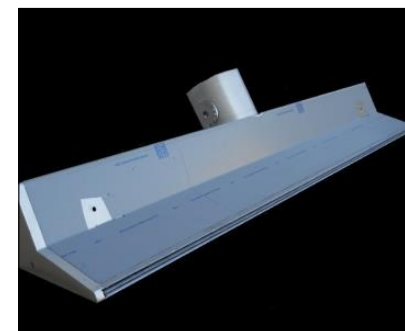

**Company ID:** 2155 VI-Italy

**Main Process:** **Medium metal constructions for small/medium Series**

**Other Process:** MIG/MAG welding for medium/large series  
Heavy metal constructions for small/medium series  
Welding in general  
Metal constructions in general  
Robot welding for small/medium series

**Materials:** AISI , Iron, Metal sheet, Ferrous materials, Tube, Tubular profile

**Markets:** ITALY

**Customers:** Structures for amusement rides and parks  
Equipment for recycling  
Energy sector in general  
Machines for the leather industry  
Automatic equipment for dosage and packaging  
Machinery for mines, quarries and construction sites

**Turnover:** 1-5 Mln €

**Certifications:** No certification      UNI EN ISO 3834-2      UNI EN ISO 1090-2 EXC 2

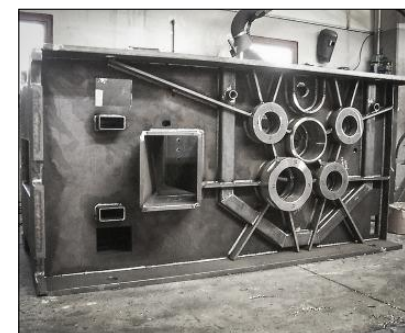



**Company ID:** 3197 VI-Italy

**Main Process:** **Heavy metal constructions for small/medium series**

**Other Process:** Medium metal constructions for small/medium Series  
MIG/MAG welding for small/medium series  
MIG/MAG welding for medium/large series  
Mechanical machining in general  
Milling in general

**Materials:** Steel, Iron, Metal sheet, Metal, Tube, Carbon steel

**Markets:** ITALY, WESTERN EUROPE, EASTERN EUROPE

**Customers:** Machines for the leather industry  
Mechanical machinery and equipment  
Textile machinery  
Machine tools  
Metallurgical plants  
Other means of transport

**Turnover:** 1-5 Mln €

**Certifications:** ISO 9001:2008      ISO 3834      UNI EN ISO 1090-2



**Company ID:** 3171 VR-Italy

**Main Process:** **Mechanical machining for medium large dimension**

**Other Process:** Heavy metal constructions for small/medium series  
Welding in general  
Robot welding for small/medium series  
Assembling of equipment, machinery and systems in general  
Painting  
Construction of equipment, machinery and systems by subcontracting

**Materials:** Steel, Stainless steel, Aluminium , Iron, High resistant steel, Alloy steel

**Markets:** ITALY

**Customers:** Equipment for recycling  
Municipal solid waste  
Energy sector in general  
Farm, forestry and animal-breeding machinery  
Other machinery for special purposes  
Metallurgical plants

**Turnover:** 5-10 Mln €

**Certifications:** ISO 9001:2008



**Company ID:** 3055 UD-Italy

**Main Process:** Mechanical precision machining

**Other Process:** Milling in general  
Turning in general  
Metal constructions in general  
Assembling of equipment, machinery and systems in general  
Welding in general  
Construction of equipment, machinery and systems by subcontracting

**Materials:** Stainless steel, Aluminium , Bronze, Cast iron, Alloy steel, Inconel

**Markets:** ITALY

**Customers:** Metallurgical plants  
Machine tools  
Shipyards Industry  
Machinery for food, beverage and tobacco processing  
Aerospace and aeronautics in general

**Turnover:** 10-50 Mln €

**Certifications:** ISO 9001:2008





**Company ID:** 3192 MI-Italy

**Main Process:** Iron casting in general

**Other Process:** Spheroidal iron casting in general  
Iron casting with SiMo in general  
Iron casting of small/medium series, weight 10-50 kg  
Spheroidal iron casting of small/medium series, weight 10-50 kg  
Iron casting of small/medium series, weight 50-100 kg  
Spheroidal iron casting of small/medium series, weight 50-100 kg

**Materials:** Cast iron, Spheroidal cast iron

**Markets:** ITALY, WESTERN EUROPE

**Customers:** Machine tools  
Equipment for rubber and plastic materials  
Textile machinery  
Metallurgical plants  
Farm, forestry and animal-breeding machinery

**Turnover:** 5-10 Mln €

**Certifications:**

