

Company ID:

3191 VI-Italy

Main Process:

Turning with sliding headstock automatic lathe in general

Other Process:

Bar turning and milling with turning and milling center CNC in general
Turning with sliding headstock automatic lathe in small/medium series, < 6 mm
Bar turning and milling with turning and milling center CNC in small/medium series, < 6 mm
Turning with sliding headstock automatic lathe in small/medium series, 6-60 mm
Bar turning and milling with turning and milling center CNC in small/medium series, 6-60 mm
Mechanical precision machining

Materials:

Stainless steel, Plastic, Titanium, Silver

Markets:

ITALY, WESTERN EUROPE

Customers:

Aerospace and aeronautics in general
Precision medical devices

Turnover:

1-5 Mln €

Certifications:

ISO 9001:2008



Company ID: 1068 VI-Italy

Main Process: Mechanical precision machining

Other Process: Turning for small and medium series, 6-60 mm
Mechanical machining in general
Turning in general
Milling in general
Heat treatments in general
Assembling groups in general

Materials: Stainless steel, Aluminium , Bronze, Brass, Plastic, Lead free cutting steels

Markets: ITALY, WESTERN EUROPE

Customers: Construction, road construction and earthmoving machines
Oil hydraulics components
Climatization and air conditioning

Turnover: 1-5 Mln €

Certifications: ISO 9001:2008



Company ID: 3225 PD-Italy

Main Process: Bar turning and milling with turning and milling center CNC in small/medium series, Ø 6-60 mm

Other Process: Mechanical precision machining
Turning with sliding headstock automatic lathe in small/medium series, 6-60 mm
Turning for small and medium series, 6-60 mm
Bar turning and milling with turning and milling center CNC in general
Mechanical machining by rework
Milling from solid material in small/medium series, table L= < 1300 mm

Materials: Stainless steel, Aluminium , Nylon, Brass, Alloy steel, Lead free cutting steels

Markets: ITALY

Customers: Hydraulics
Refrigeration
Class room, hospital, public agencies furniture
Equipment for cycles and motor-cycles
Machine tools
Oil hydraulics components

Turnover: 1-5 Mln €

Certifications: ISO 9001:2000



Company ID: 178 TV-Italy

Main Process: Turning for small and medium series, \varnothing 6-60 mm

Other Process: Turning for small and medium series, $>$ 60 mm
Mechanical machining in general
Milling in general
Surface treatments in general
Mechanical machining by transfer
Mechanical precision machining

Materials: Stainless steel, Aluminium , Ferrous materials, Brass

Markets: ITALY

Customers: Oil hydraulics components
Home electric appliances
Furnishing and lighting in general
Hydraulics
Motor-bikes and motor-cycles in general
Furnishing elements

Turnover: $<$ 1 Mln €

Certifications: No certification



Company ID:

749 VI-Italy

Main Process:

Turning for small and medium series, \varnothing 6-60 mm

Other Process:

Turning for small and medium series, $>$ 60 mm
Turning in general
Turning for medium to large series, 6-60 mm
Milling in general
Broaching in general
Surface treatments in general

Materials:

Stainless steel, Brass, Plastic, Aluminium alloys, Alloy steel, Free cutting steels

Markets:

ITALY, WESTERN EUROPE, EASTERN EUROPE

Customers:

Oil and gas
Automotive in general
Home electric appliances
Hydraulics
Furnishing
Furnishing and lighting in general

Turnover:

1-5 Mln €

Certifications:

ISO 9001:2008



Company ID: 3100 BG-Italy

Main Process: **Mechanical machining in general**

Other Process: Milling from casted material in small/medium series, table L = 1300-1600 mm
Turning in general
Milling in general
Drilling in general
General sandblasting
Trimming in general

Materials: Steel, AISI , Aluminium , Bronze, Cast iron, Carbon

Markets: ITALY

Customers: Automotive in general
Energy sector in general
Aerospace and aeronautics in general
Oil hydraulics components
Pumps and compressors
Components and plant parts for the food and wine-making industries

Turnover: < 1 Mln €

Certifications: ISO 9001:2008



Company ID: 3111 TN-Italy

Main Process: M.I.M. Metal injection moulding in general

Other Process:

Materials: Stainless steel, Bronze, Copper, Titanium, Alloy steel, Superalloys

Markets: ITALY

Customers: Motor-bikes and motor-cycles in general
Industry and components
Medical, surgical and orthopaedic appliances
Components for sporting weapons

Turnover: 1-5 Mln €

Certifications: ISO 9001:2008

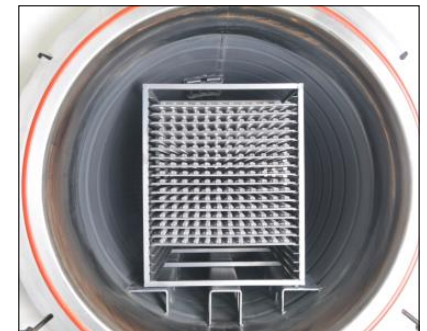

Company ID: 747 PD-Italy

Main Process: Cold-chamber aluminium pressure die casting, small/medium series, presses 250-700 t

Other Process: Cold-chamber aluminium pressure die casting, medium/large series, presses 250-700 t
Pressure die casting in general
Trimming in general
General sandblasting
Vibrofinishing, Electropolishing
Mechanical machining in general

Materials: Aluminium , Aluminium alloys

Markets: ITALY, WESTERN EUROPE, EASTERN EUROPE

Customers: Heating systems
Pumps and compressors
Automotive in general
Furnishing
Home electric appliances
Lighting systems

Turnover: 1-5 Mln €

Certifications: ISO 9001:2008

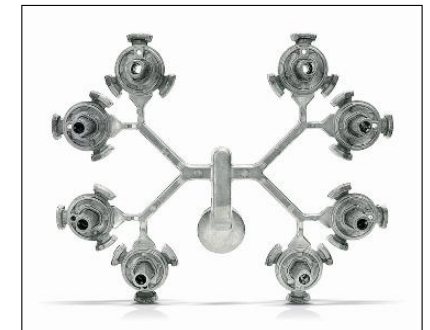

Company ID: 3192 MI-Italy

Main Process: Iron casting in general

Other Process: Spheroidal iron casting in general
Iron casting with SiMo in general
Iron casting of small/medium series, weight 10-50 kg
Spheroidal iron casting of small/medium series, weight 10-50 kg
Iron casting of small/medium series, weight 50-100 kg
Spheroidal iron casting of small/medium series, weight 50-100 kg

Materials: Cast iron, Spheroidal cast iron

Markets: ITALY, WESTERN EUROPE

Customers: Machine tools
Equipment for rubber and plastic materials
Textile machinery
Metallurgical plants
Farm, forestry and animal-breeding machinery

Turnover: 5-10 Mln €

Certifications:

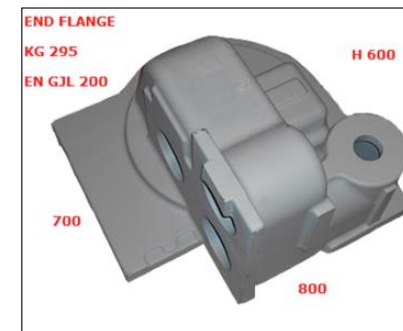

Company ID: 3150 TV-Italy

Main Process: 2D Laser cutting for small/medium series

Other Process: Metalsheet bending by press brake in general
2D Laser cutting for medium/large series
Sheet bending by oil hydraulic press brake, small/medium series, L= 3000-4000 mm
Punching in general
Metal sheet calendaring in general
Welding in general

Materials: Stainless steel, Aluminium, Pickled steel, Metal sheet, Rolled steel, Stainless rolled steel

Markets: ITALY

Customers: Pasta and farinaceous products
Components and plant parts for the food and wine-making industries
Machine tools
Machinery for food, beverage and tobacco processing
Automatic equipment for dosage and packaging
Machines for the pharmaceutical sector

Turnover: 1-5 Mln €

Certifications: No certification

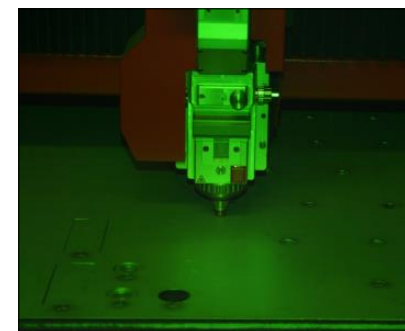
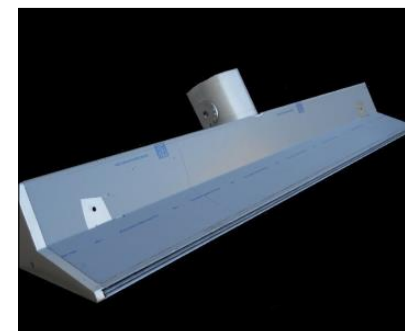

Company ID: 843 MI-Italy

Main Process: Deep drawing of metal sheet in general

Other Process: Metal sheet drawing die
Blanking die
Metal sheet stamping in general
Metal sheet stamping, medium/large series, mechanical presses 250-600 t
Metal sheet stamping, medium/large series, hydraulic presses 250-600 t
Metal sheet stamping with transfer die, presses 250-600 t

Materials: Stainless steel, AISI , Aluminium , Metal sheet, Ferrous materials, Non-ferrous materials

Markets: ITALY, WESTERN EUROPE

Customers: Home electric appliances
Furnishing and lighting in general
Climatization and air conditioning
Automotive in general
Pumps and compressors
Medical, surgical and orthopaedic devices

Turnover: 1-5 Mln €

Certifications: ISO 9001:2000

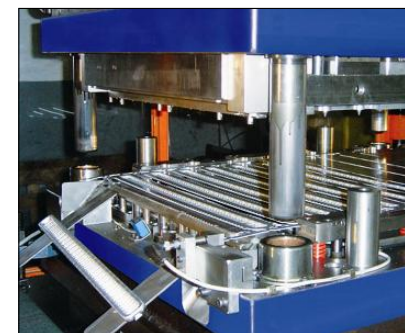

Company ID: 3139 TV-Italy

Main Process: Wiring and electrical assemblies

Other Process: Assembling groups in general

Materials: Electrical materials, Electric cables

Markets: ITALY, WESTERN EUROPE

Customers: Home electric appliances
Electronics in general
Car equipment
Energy sector in general
Machinery/Equipment for the automatic distribution of products
Motor-bikes and motor-cycles in general

Turnover: 1-5 Mln €

Certifications: ISO 9001:2000 UL CSA

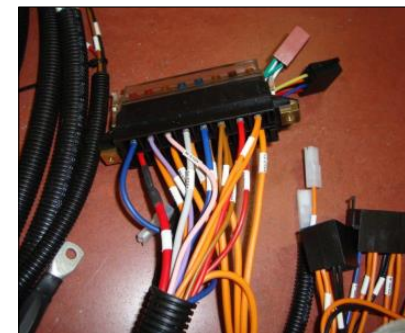

Company ID: 3127 TV-Italy

Main Process: Plastic material moulding in general

Other Process: Plastic injection moulding, in small/medium series, moulding presses < 420 t
Plastic injection moulding in small/medium series, moulding presses 420-800t
Two-component plastic injection moulding
Multi plastic material injection moulding (MMM)
Plastic material co-injection moulding
Gas/air assisted plastic injection moulding

Materials: Dual-material, Plastic, Polymers, Polypropylene, Technopolymers, Thermoplastic material

Markets: ITALY, WESTERN EUROPE

Customers: Furnishing elements
Home electric appliances
Motor-bikes and motor-cycles in general
Sports clothes, shoes and accessories
Footwear and accessories
Industry and components

Turnover: 1-5 Mln €

Certifications: No certification

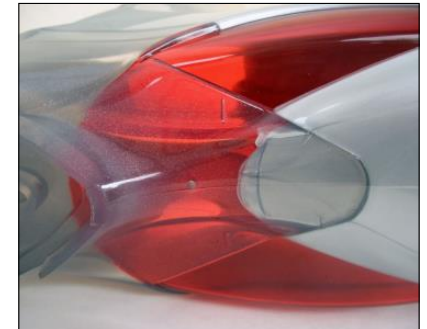
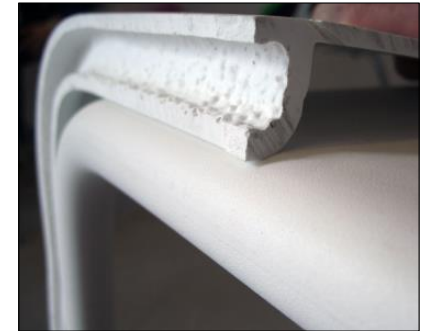

Company ID: 336 BL-Italy

Main Process: Plastic material moulding in general

Other Process: Injection moulds for plastic material
Dies design
Assembling groups in plastic/rubber
Plastic printing by pad
Painting

Materials: Polycarbonate, Technopolymers, Thermoplastic material, ABS (acrylonitrile butadiene styrene), PBT (Polybutylene terephthalate), Polyamide

Markets: ITALY, WESTERN EUROPE, EASTERN EUROPE

Customers: Automotive in general
Lighting systems
Heating systems
Industrial electronics
Industry and components
Pumps and compressors

Turnover: 10-50 Mln €

Certifications: ISO 9001:2008 UL CSA OHSAS 18001
ISO/TS 16949:2009



Company ID:

100 VI-Italy

Main Process:

Injection moulds for plastic material

Other Process:

Dies/Moulds in general
Mechanical precision machining
Wire EDM

Materials:

Special steel, Hardened steel

Markets:

ITALY, WESTERN EUROPE, EASTERN EUROPE

Customers:

Automotive in general
Precision medical devices
Industrial electronics
Lighting equipment and electric lamps
Medical, surgical and orthopaedic devices
Lighting systems

Turnover:

1-5 Mln €

Certifications:

ISO 9001:2008

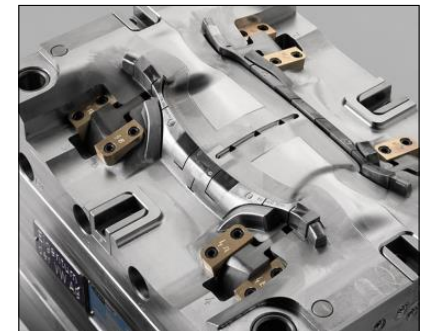
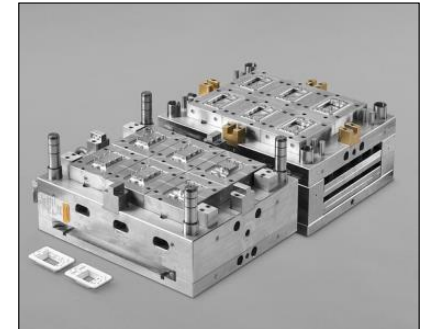

Company ID: 3081 VR-Italy

Main Process: Injection moulds for plastic material

Other Process: Plastic injection moulding, in small/medium series, moulding presses < 420 t
Plastic injection moulding in medium/large series, moulding presses < 420 t
Blanking die
Pilot dies
Assembling groups with different materials
Moulds for M.I.M. Metal Injection Molding

Materials: Steel, Thermoplastic material, Hardened steel, PMMA (Polymethyl methacrylate)

Markets: ITALY, WESTERN EUROPE

Customers: Hydraulics
Electronics in general
Electrotechnics in general
Basic products of the chemical industry
Medical industry in general
Gardens and gardening

Turnover: 1-5 Mln €

Certifications: ISO 9001:2000

